



Anti-shock combination air valve for industry

Mod. GOLIA 3F - AS

The CSA anti-shock, non slam, surge dampening combination air valve Mod. GOLIA 3F AS will allow the release of air pockets during working conditions, the entrance of large volumes of air during draining operations and pipeline bursts and the air discharge with controlled speed, to avoid potential damages due to water hammer.



Technical features and benefits

- Entirely made in high resistant materials suitable for industrial and aggressive environments.
- Mobile block composed of a cylindrical float and upper disk in solid polypropylene, that are joined together by the CSA air release system. The solid cylindrical floats avoid deformations and ensure a great sliding precision.
- Nozzle and gasket holder, part of CSA air release system, entirely made in AISI 316/Duplex and designed with gasket compression control to prevent aging process and consequent leakage during working conditions.
- Anti-water hammer surge prevention system (also called AS function), never in contact with water, obtained by a spring and shaft in stainless steel, disk with adjustable sonic nozzles for air flow control.
- Mesh and cap in stainless steel.
- High flow design with reduced turbulence thanks to the single chamber design.
- Supplied with flanged or threaded outlets including studs.

Applications

- Seawater main transmission lines. Desalination plants.
- Demineralized water.
- Mining.
- Refineries and petrochemical plants.
- To protect pumping stations and nodes of sewage main transmission lines exposed to water hammer and column separation in case of pump failure.

Operating principle



Entrance of large volumes of air

During pipeline draining, or pipe bursts, it is necessary to bring in as much air as the quantity of outflowing water to avoid negative pressure and serious damages to the pipeline, and to the entire system.



Controlled air discharge

During the air discharge it is necessary to avoid rapid closures of the float, responsible of water hammer effects. The Golia 3F AS, thanks to the anti-shock feature, will control the air outflow thus reducing the velocity of the approaching water column and minimizing the risk of overpressure.

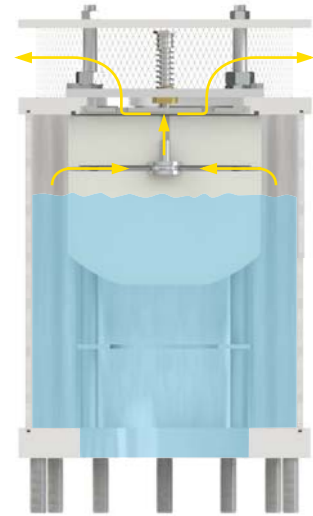

Air release during working conditions

During operation the air produced by the pipeline is accumulated in the upper part of the air valve. Little by little it is compressed and the pressure arrives to water pressure, therefore its volume increases pushing the water level downwards allowing the air release through the nozzle.

Optional



■ **Vacuum breaker version Mod. Golia 2F AS**, to allow the entrance of large volumes of air and the controlled outflow only. This model is normally recommended in changes in slope ascending, long ascending segments, dry fire systems.



■ **Version for submerged applications, SUB series**, available both for Golia 3F AS and 2F AS Models, with elbow for air conveyance. The design sprang from the necessity of having an air valve performing also in case of flood, without the risk of contaminated water entering the pipeline. Another benefit of SUB is to avoid the spray effect, conveying spurts coming from the closure away from the air valve.



■ The counteracting spring force as well as the sonic nozzles, both responsible of the proper operation of the AS device, can be modified on request according to the project conditions and the result of transient analysis.

Technical data

Air valve selection chart

Air valve preliminary sizing as a function of pipeline internal diameter and fluid flow velocity in m/s.

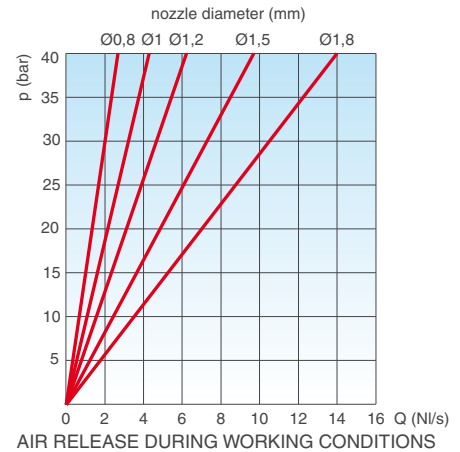
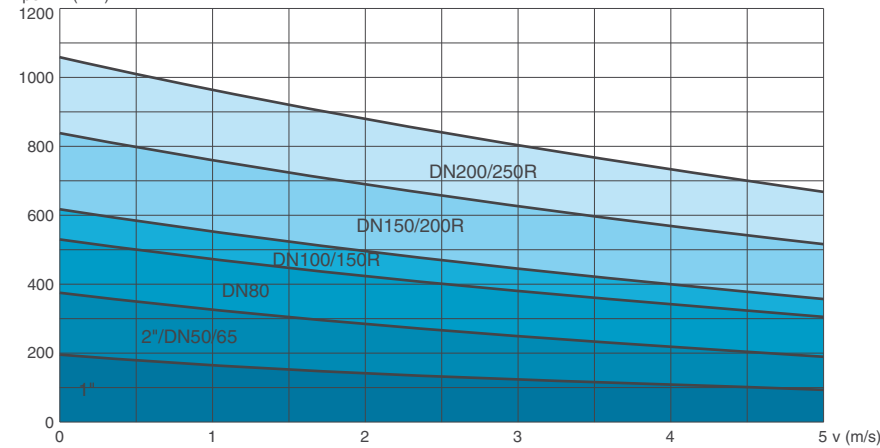

Air flow performance charts

AIR ENTRANCE DURING PIPE DRAINING

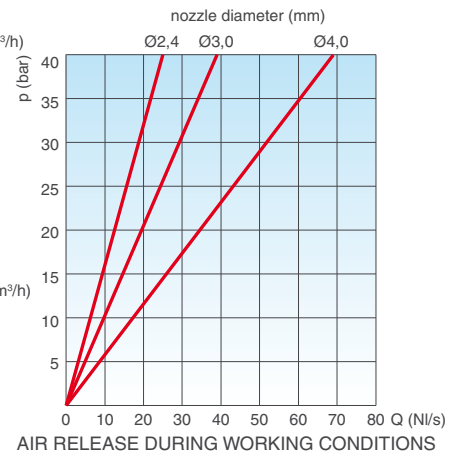
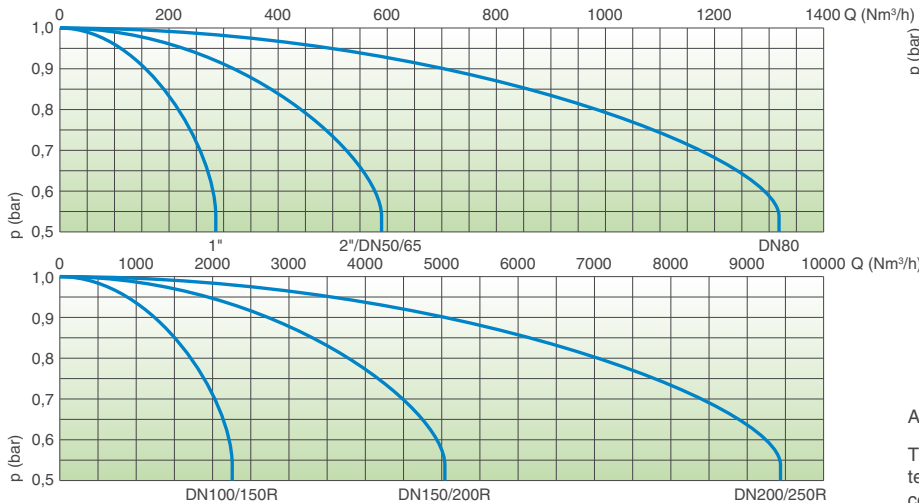

The air flow charts were created in Kg/s from laboratory tests and numerical analysis without the screen, then converted in Nm³/h using a safety factor.

Working conditions

- Treated water max. 60°C.
- Max. pressure 40 bar.
- Min. pressure 0,2 bar. Lower pressure on request.
- Version for high temperatures on request.

Standard

- Designed in compliance with EN-1074/4 and AWWA C-512.
- Flanges according to EN 1092/2 or ANSI.
- Gaskets in NBR, EPDM or Viton.
- Changes and variations on the flanges and gaskets on request.

Weights and dimensions

CONNECTION inch/mm	A mm	B mm	C mm	Weight Kg
Threaded 1"	95	200	-	6,4
Threaded 2"	165	255	-	6,4
Flanged 50	165	255	40	8,0
Flanged 65	185	255	40	8,0
Flanged 80	200	285	50	12,0
Flanged 100	235	335	50	17,0
Flanged 150R	235	385	50	27,0
Flanged 150	300	445	70	45,0
Flanged 200R	360	445	70	49,0
Flanged 200	360	515	70	62,0
Flanged 250R	405	515	70	72,0

R: reduced bore. Larger sizes available on request.

All values are approximate, consult CSA service for more details.

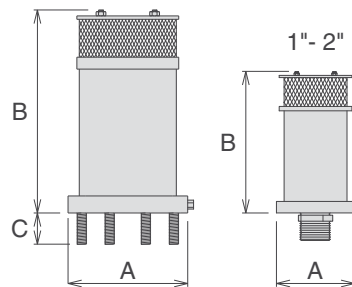

Nozzle choice

	PN 10	PN 16	PN 25	PN 40
1"	1,2	1,2	1	0,8
2"/DN 50/65	1,5	1,2	1	0,8
DN 80	1,8	1,5	1,2	1
DN 100/150R	2,4	1,8	1,8	1,2
DN 150/200R	4	3	2,4	1,8
DN 200/250R	4	4	4	3

Nozzle diameter in mm according to the size of the air valve and the PN.

Technical details

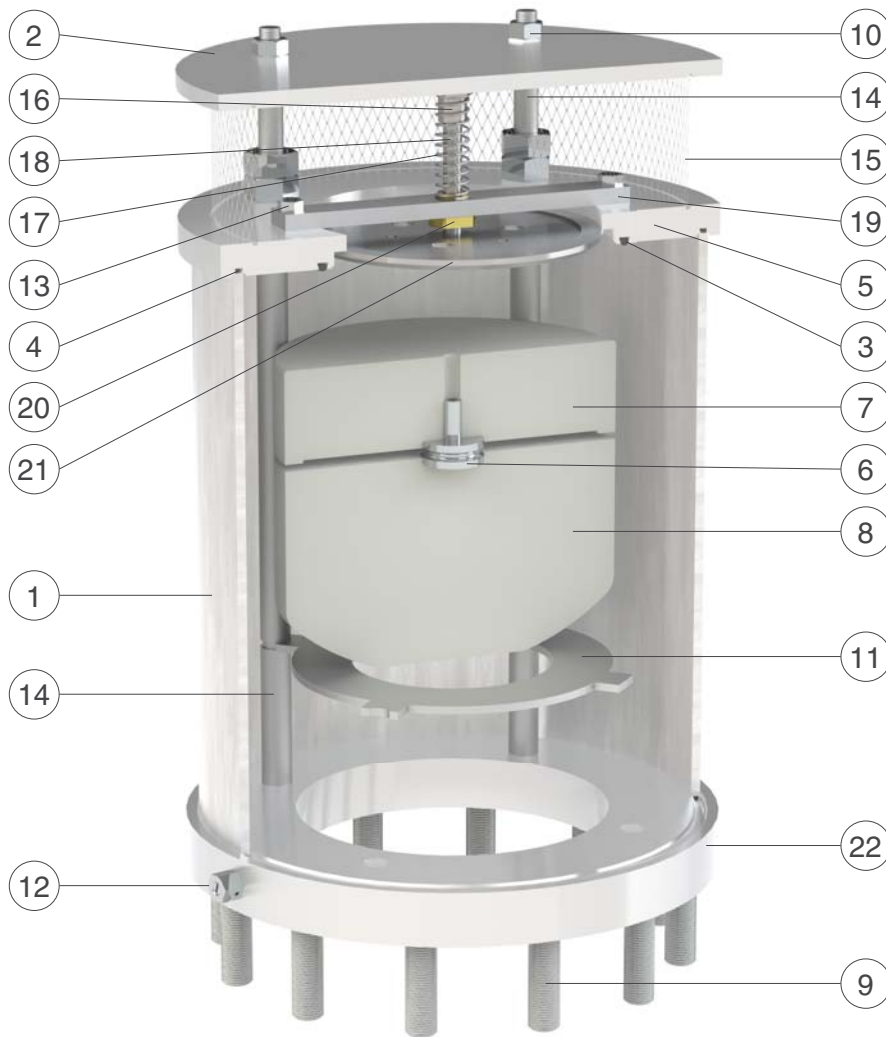

N.	Component	Standard material	Optional
1	Body	stainless steel AISI 316	s.s. Duplex/Super Dupl.
2	Cap	stainless steel AISI 304	stainless steel AISI 316
3	O-ring	NBR	EPDM/Viton/silicone
4	O-ring	NBR	EPDM/Viton/silicone
5	Seat	stainless steel AISI 316	s.s. Duplex/Super Dupl.
6	Nozzle subset	stainless steel AISI 316	stainless steel Duplex
7	Upper flat	polypropylene	
8	Float	polypropylene	
9	Studs	stainless steel AISI 304	stainless steel AISI 316
10	Nuts	stainless steel AISI 316	
11	Deflector	stainless steel AISI 316	s.s. Duplex/Super Dupl.
12	Drainage valve	stainless steel AISI 316	
13	Screws (from DN 150R)	stainless steel AISI 316	
14	Spacers	stainless steel AISI 316	s.s. Duplex/Super Dupl.
15	Screen	stainless steel AISI 304	stainless steel AISI 316
16	Spring guide nut (from DN 100)	stainless steel AISI 303	stainless steel AISI 316
17	Spring	stainless steel AISI 302	stainless steel AISI 316
18	AS shaft	stainless steel AISI 303	stainless steel AISI 316
19	Spring support (from DN 150R)	stainless steel AISI 304	stainless steel AISI 316
20	Guiding nut (from DN 150R)	Delrin (polyoxymethylene)	
21	AS flat	stainless steel AISI 316	
22	Flange	stainless steel AISI 316	s.s. Duplex/Super Dupl.

The list of materials and components is subject to changes without notice.